



## **MRD1-G – Generator Differential Protection System**

**Manual MRD1-G (Revision A)**

Woodward Governor Company reserves the right to update any portion of this publication at any time. Information provided by Woodward Governor Company is believed to be correct and reliable. However, no responsibility is assumed by Woodward Governor Company unless otherwise expressly undertaken.

© Woodward 1994-2008

## Contents

<b>1.</b>	<b>Introduction and Application .....</b>	<b>5</b>
<b>2.</b>	<b>Features and Characteristics .....</b>	<b>6</b>
<b>3.</b>	<b>Design .....</b>	<b>7</b>
3.1	Relay front .....	7
3.1.1	Display .....	7
3.1.2	LEDs .....	7
3.1.3	Push-buttons .....	8
3.1.4	Parameter interface RS232 .....	8
3.2	Master module .....	8
3.2.1	Interface RS485 .....	8
3.3	Basic module .....	9
3.3.1	Basic module NT 6I .....	9
<b>4.</b>	<b>Working principle .....</b>	<b>10</b>
4.1	Protective functions .....	10
4.1.1	Generator differential protection .....	10
4.2	Analog measured value detection .....	14
4.2.1	Current measuring .....	14
4.3	Digital signal processor .....	14
4.4	Digital main processor .....	14
4.5	Block diagram .....	15
4.6	General functions .....	16
4.6.1	Event-Recorder .....	16
4.6.2	Fault-Recorder .....	16
4.6.3	-test relay .....	16
4.6.4	Self-test .....	17
4.6.5	Output relay settings .....	17
4.6.6	Parameterising blocking .....	18
<b>5.</b>	<b>Operation .....</b>	<b>19</b>
5.1	General .....	19
5.1.1	Data organization .....	19
5.1.2	Parameter sets .....	20
5.1.3	Key function .....	21
5.1.4	LEDs .....	22
5.1.5	VIEW mode / EDIT mode .....	23
5.1.6	OFFLINE-TEST mode .....	24
5.1.7	Reset (DEVICE RESET) .....	24
5.1.8	Enter password .....	25
5.1.9	Password forgotten .....	25
5.2	SYSTEM settings .....	26
5.2.1	Selection .....	26
5.2.2	Overview .....	27
5.2.3	Time / Date .....	28
5.2.4	Password change .....	29
5.3	PARAMETER-pages .....	30
5.3.1	Selection .....	30
5.3.2	Overview .....	31
5.3.3	Generator ratings .....	32
5.3.4	Protection parameters .....	33
5.3.5	Relay-settings .....	35
5.3.6	Setting of logic functions .....	36
5.3.7	Blocking Setting .....	38
5.3.8	Validity check .....	39
5.4	DATA pages .....	40
5.4.1	Selection .....	40
5.4.2	Overview .....	41
5.4.3	Measured and calculated data .....	41
5.4.4	FAULT Recorder .....	42

---

5.4.5	EVENT-Recorder .....	43
5.4.6	Statistic data .....	43
5.5	TEST-routines page (Self-test) .....	44
5.5.1	Page selection .....	44
5.5.2	Overview .....	44
5.6	Parameter programming help .....	45
<b>6.</b>	<b>Relay Tests .....</b>	<b>46</b>
<b>7.</b>	<b>Commissioning .....</b>	<b>47</b>
7.1	Check list .....	47
7.2	C.T. connection .....	47
<b>8.</b>	<b>Technical Data .....</b>	<b>49</b>
8.1	MRD - G Generator Differential Protection Relay .....	49
<b>9.</b>	<b>Tables/Connection diagrams .....</b>	<b>52</b>
9.1	Possible event messages .....	52
9.2	View .....	53
<b>10.</b>	<b>Order form .....</b>	<b>55</b>

# 1. Introduction and Application

---

MRD1 is a modular system to protect electrical apparatus and it is used for complex applications in the energy distribution, primarily de-signed for transformer, generator, motor or line protection; additionally it can be integrated into automation systems. Due to its modular design, the MRD1 can be adapted to individual applications without problem, with all implemented functions remaining combined in one single device. All vacant rack places in the basic unit can optionally be used for modules according to requirements. The modules provide the necessary measuring inputs e.g. for two-winding or three-winding transformers as well as increase the number of output re-lays or digital inputs according to requirements.

The high-performance digital technique of data calculation makes complex mathematical algorithm for measured value processing possible for the MRD1 as well as utilization of the trip decision resulting from the individual protection functions. The MRD1 software is also of modular structure. Each protection function is allocated to a special program segment and so it is possible to subsequently add further functions.

All essential parameters, measuring data or values calculated from these can be called off and are shown locally on the display. The MRD1 is equipped with an Event Recorder which stores all system signals, protection activations or trip events. When trips occur a Fault Recorder records all fault data measured at the instant of the trip. Data of both recorders is provided with a time stamp and can be called off either at the display or interface.

At present the following versions of MRD1 are available:

- MRD1-T2 Transformer differential protection for two-winding transformers
- MRD1-T3 Transformer differential protection for three-winding transformers
- MRD1-G Differential protection for generators and motors

## 2. Features and Characteristics

---

### Basic Unit

#### Standard equipment

- Modular design with automatic short circuiting C.T.-inputs
- Signal and data processing in a separate digital signal processor (32 samples per cycle)
- Digital filtering of measured quantities
- Three possibilities of parameter setting and data calling:
  - 1) keyboard and display
  - 2) RS232 interface at the front (laptop)
  - 3) RS485 interface for integration into control systems at the rear
- Safety interlocking preventing parameter setting via different ways at the same time
- extensive internal plausibility check of modified parameters
- Event Recorder for recording system messages
- Fault Recorder for recording measured fault data
- Four programmable independent parameter sets
- Non-volatile memory for parameter sets, events and fault data
- Indication of measured operational values and resulting quantities
- Wide-ranging automatic self-tests
- Small relay size
- Three possibilities for relay re-setting
- Indication of relay function optically or via separate self supervision relay
- All data interfaces galvanical isolated
- Rated frequency selectable: 50 Hz/60 Hz
- Parameter setting protected by password

#### Functions which can be programmed by the user :

- Protection and system parameters
- Latched position or minimal signal duration for each of the output re-lays

#### Generator differential protection

- Stabilization against CT measuring errors
- No complete blocking of differential element but only reduced sensitivity
- Independent High Set differential element for heavy faults

## 3. Design

This chapter informs briefly about operation elements and indication elements of the MRD1. Name and position of the individual modules are also described. In chapter 5 operating of the relay and type specific functions are explained in more detail.

### Note

Front view and rear view illustrations of the MRD1 as well as connection diagrams can be found at the end of the manual.

### 3.1 Relay front

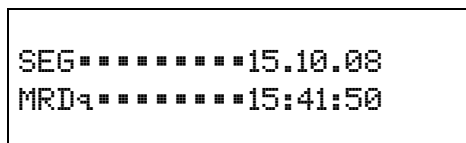

Display in Home Position

#### 3.1.1 Display

The MRD1 is provided with a 16-digit, double-line liquid crystal display (LCD), which is of alphanumerical design for an easy dialog. The figure above shows the basic status of the display. De-pendent on the mode selected, the following data can be shown on the display:

- Date / Time / Relay type (Home Position)
- Measured operational data
- Measured fault data
- System parameters and protection parameters
- System signals and fault signals

#### 3.1.2 LEDs

Additionally to the display there are max. 15 LEDs at the front, indicating each of the operational status in the MRD1. All LEDs are two-colored (red/green) and arranged in two groups:

##### System and relay status indications

The 15 system indications are arranged underneath the alphanumerical display. They are allocated to a certain function and show:

- Operational voltage available
- Trip
- OFFLINE TEST mode active
- Edit mode active
- Displayed parameter is modified but has not been stored yet
- Switch status of the 5 output relays
- Display of the relay function (self-test)

### 3.1.3 Push-buttons

All necessary MRD1 adjustments and inquiries can be carried out from the front of the relay by pressing the respective push-button (9 in total). Individual function of these push-buttons is explained in chapter Operating.

### 3.1.4 Parameter interface RS232

At the left of the relay front there is a 9-pole, D-SUB plug-and-socket connector for temporary laptop connection. At this connection a serial interface RS-232 is provided. A standard IBM™ compatible PC or portable notebook can be connected to this PC interface. To connect MRD1 and PC a 1:1 modem-cable with 9-pole plug-and-socket is used. By using Woodward software HTLSOFT 3, which is Windows™ compatible, MRD1 parameters can comfortably be set. Additionally all measured operational and fault data can be read out of the relay integrated non-volatile memories and the optional fault recorder.

## 3.2 Master module

The master module is fitted right in the middle and contains components for data processing, the main processor and the following connections:

### 3.2.1 Interface RS485

Interface RS485 at the rear of the relay is a permanent connection between the MRD1 and the host computer. This interface operates at a constant transmission ratio of 9600 Baud if Woodward protocol "RS485pro" is used. Via RS485 interface all measured operational and fault data as well as operational status indications can be read out - identical to RS232 interface. Remote setting of parameters is also possible from the control station. The 8-pole plug-and-socket connector contains all necessary connections for this interface.



### 3.3 Basic module

Plug-in units 1 and 3 are intended for individual applications and at our works they are equipped with modules for measuring value detection in compliance with the relay function. (see folding page)

#### Important Note

The MRD1 must only be dismantled or opened by authorized staff . Removal of live modules entail severe danger for the person(s) involved because there can be no sufficient protection against accidental contact as soon as the relay has been opened. Furthermore there is the risk of the modules being damaged by electrostatic discharge (ESD/EGB) when handled improperly.

Identical modules must not be exchanged between different MRD1 basic versions.

Calibration of every MRD1 is done at work with regard to the specific features of that relay. A random change of modules would lead to unreliable operation of the relay because the compatibility of the relay components among each other would be in disorder and could not be guaranteed any longer.

Any modification jobs on the MRD1, for instance, exchange of modules or software additions, are only allowed to be done at our works or by authorized agents.

#### 3.3.1 Basic module NT 6I

For generator, motor and transformer differential protection, module NT-6I is plugged into the first space.

##### Measuring inputs

The module consists of six current measuring channels which are used for measuring the three conductor currents of each winding. The CT start point must be formed outside the relay since all 12 CT connections are wired separately on terminals. In addition to other measuring or protection devices the MRD1 can be looped in to existing CT lines, assumed the CT being able to carry the total burden.

Apart from further connections for voltage supply of the relay, the module is also provided with a digital input for remote resetting as well as connection facilities for the five output relays. Four of these are free to be used according to requirement; the fifth is assigned for Self test Relay.

##### RESET Input

If a voltage is applied to terminals of the RESET input (C8-D8), the MRD1 is reset to its basic status. By this procedure possible alarms and trip signals are cancelled.

The voltage applied for resetting must be within the permissible high-range (see technical data), although it must not necessarily be identical with the latter. The input is galvanically isolated from the relay electronics. Contact D8 is also the neutral or minus for the blocking input.

##### Blocking Input

If a voltage is applied to the terminals of the blocking input (D8-E8), all protection functions assigned to the output relays are blocked. Terminal D8 is also the neutral or minus for the input.

##### Alarm relays

Potential free outputs of the five alarm relays provided are at terminals C, D and E, series 1 to 7. Exact allocation can be taken from the connection diagram. Relay 5 is permanently assigned to Self test Relay. Function allocation of the remaining relays is free and can be defined when programming (see chapter 5). Two of these four relays are provided with two changeover contacts each and the other two with one changeover contact each.

## 4. Working principle

In this chapter the individual functions and working principle of the MRD1 are described.

### 4.1 Protective functions

#### 4.1.1 Generator differential protection

	Term	Explanation
ID	Bias current	This is the current passing through the generator from the star point side to the grid side. This current is representing the normal load.
Id	Differential current	The difference between grid side current and star point side current of one winding.
Ia	Pickup current	If the differential current exceeds the pickup current, the relay trips.
	Fault current due to operational conditions	This kind of fault current is the component of the measured differential current which, however, is not caused by a fault of the object to be protected but is of systematic nature
	Stabilisation	Under this heading all measures are compiled which stabilise the differential relay against nuisance tripping. Stabilising always means the pickup current is raised and by this the differential relay becomes more intensive, but is never completely blocked.
I <sub>s</sub>	Stabilising current	This current develops from the bias current and represents the extent of stabilising measures necessary as result of the fundamental analysis. Parameters of the pickup characteristic can be set.
m	Harmonic stabilising factor	This factor, derived from the analysis of the harmonic frequency, is apart from I <sub>s</sub> the second stabilising factor and in case of rush and saturation by following a special characteristic makes the differential relay stable against tripping errors.
d[Id]	Characteristic Offset	The characteristic curve is raised up by the value d[Id] immediately after a harmonic stabilisation factor "m" is measured to be greater than zero. This is to give a basic stabilisation after detection of inrush or ct-saturation during external fault by means of harmonic measurement.
	Pickup characteristic	This characteristic defines the stabilising current dependence on the pickup current

Table 4.1: Term definitions

**General idealized view**

Differential protection is a strict selective object protection and is based on the current measuring principle at the input and output side of the object being protected. Dependent on the earthing method used, the neutral can also be included in measuring and balance.

The area between input and output CTs of the object is classed as protection zone supervised by the MRD1. Included in the protection zone are also CTs and CT connection wire to the relay.

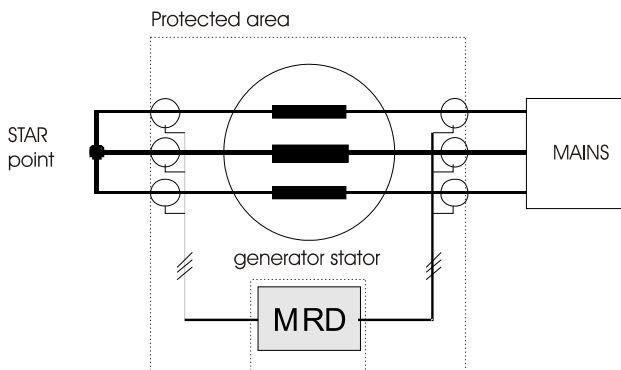

Figure 4.1: Definition of protection zone

The relay checks constantly if the incoming currents of a winding are met by respective outgoing currents. If the balance of the conductor currents shows a difference, this may suggest a fault within the protection zone.

**Note!**

Motors and generators are to be handled from the differential protection in the same way.

To distinguish between faults occurring within (internally) or outside (externally) of the protection zone is the main purpose of the differential protection because at internal faults the differential protection relay must trip, but not so at external faults.

**Examples:**

**External fault**

During a short circuit occurring at the grid, the short circuit current flows through the generator. The difference between incoming and outgoing currents of all generator terminals is small (in ideal cases = zero)  $I_1 - I_2 = 0$ . The differential protection relay does not trip. (Switching off in such cases probably to be realized by an over current relay).

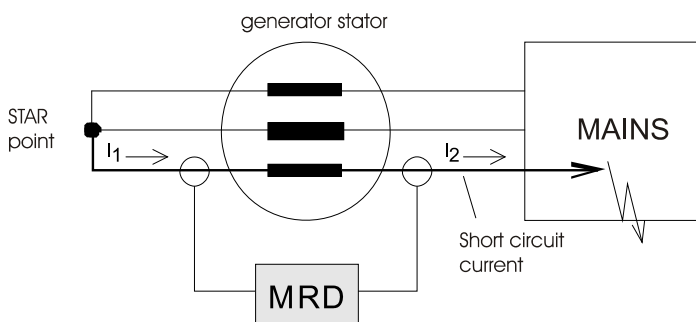

Figure 4.2: External fault

### Internal fault

When an internal fault occurs the current balance is different. Dependent on the kind of fault a deficit in the total of incoming currents can be observed. A winding short circuit, for instance, can be fed from both sides, even if with different intensity. But this short circuit does not go through the generator, it is fed from both sides into the generator. So therefore the current balance shows a difference.

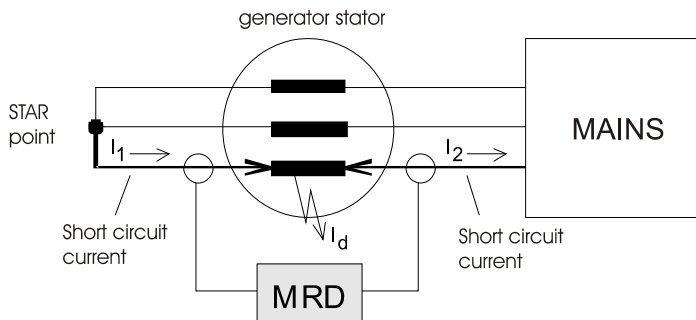

Figure 4.3: Internal fault (example of a short circuit fed from two sides)

Due to the chosen direction of the reference arrow, current  $I_2$  flows here in negative direction.

The differential relays detects a current difference of  $I_1 - I_2 = I_d$  and trips when  $I_d$  has exceeded the set threshold.

### Stabilizing

At first approximation this idealized view applies to stationary states only. In reality other effects, especially CT errors, may cause the established current difference to rise, even if there is no internal fault. In such cases a simple static differential relay would mistakenly trip and to prevent this stabilizing measures have to be taken. Possible sources of measuring errors are systematic and can be duly taken into account.

Stabilizing the MRD1 means always an action to make the relay more insensitive.

### Fundamental analysis

Distortion factors for differential current measuring are:

- Measuring errors of angle and value of the CTs used
- Poor adjustment of rated CT data to rated generator data

By these factors a fault current is caused which mainly depends on the biasing current. This fault current is being measured as a differential current, although a generator fault must not necessarily have occurred. When the pickup current is set at a very sensitive value, each of these factors can cause unintended trip-pings. With increasing bias current the pickup current has to be corrected upwardly.

The following pickup characteristic (exact characteristic) gives an detailed study of the individual fault factors and the resulting fault current. In fig. 4 the expected fault current versus tripping characteristic is shown.

If a real fault occurs, the measured differential current exceeds the biasing current caused by operational conditions. Therefore the pickup characteristic must exceed the biasing current characteristic by the required sensitivity value. The exact course can be approximated by a simplified characteristic consisting of two linear sections (I and II). The higher the characteristic begins, the higher the permissible differential current. If the characteristic begins at a very low point this means maximum sensitivity. If the pickup characteristic is below the biasing characteristic, systematic effects can cause unintended trips.

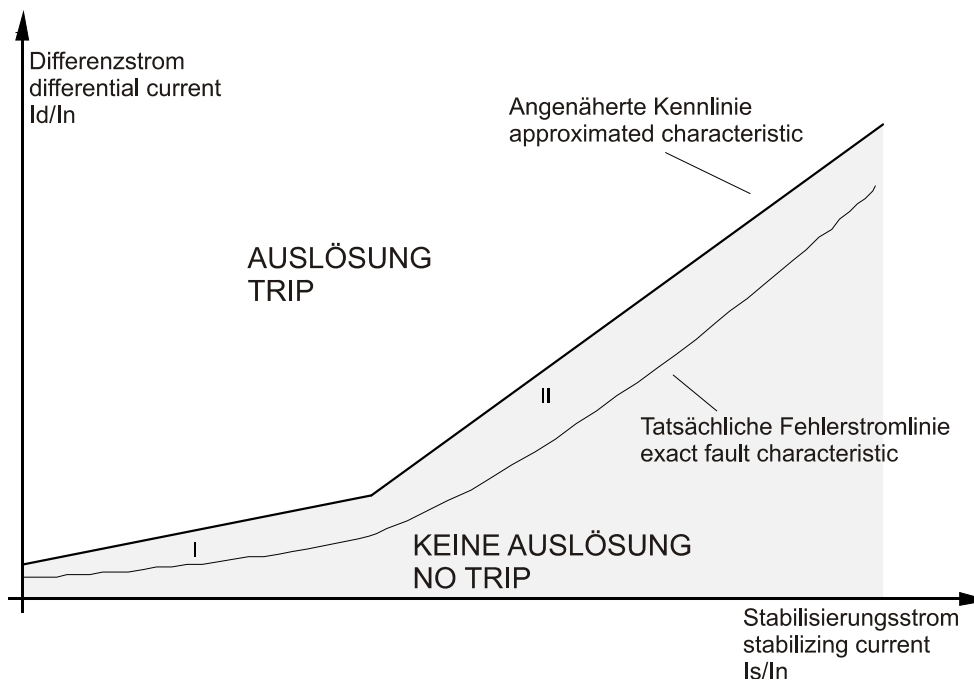

Figure 4.4: Typical pickup characteristic (without considering transient processes)

Calculation of the differential current and stabilizing current resulting from the fundamental oscillation (current of the positive phase sequence system) produces a point on the characteristic. If this point is within the tripping range, the output relay picks up. In case of harmonics of 4th or 5th order in the differential current the characteristic curve is raised up statically by the parameter  $d[Id]$  and dynamically by the measuring value  $m$  (characterizes the harmonic contents).

#### Tripping procedure

The protection program permanently checks the measurements that the DSP (digital signal processor) delivers. When the DSP gives a new differential current the protection task checks whether it lies within the tripping limits. If this is the case the MRD1 is internally energized. Tripping occurs when the calculated difference current is consecutively three times within the tripping limits. To prevent the energized state from being reset too quickly, a hysteresis of 75 % is programmed. This means that a newly calculated difference current must be smaller than 75 % of the pre-sent characteristic trip value in order for the energized condition to be reset. The total tripping time of the Relay is below 35 ms.

## 4.2 Analog measured value detection

### 4.2.1 Current measuring

For measuring the relevant currents there is a separate transducer for each of the existing measured quantities. This transducer provides galvanical isolation to the relay electronics. Adjustment to the main CT rated currents is realized via the software. The input signal is transmitted by internal CTs up to 64 times rated current linear. To achieve an utmost accuracy there are two current measuring ranges, changeover of which is automatically.

Each channel has its own sample-and-hold circuit. All channels are scanned simultaneously.

### 4.3 Digital signal processor

The digital signal processor (DSP) in the MRD1 is mainly used for processing measured values by controlling and monitoring data entry from the different measuring channels. In addition all input signals are digitally Fourier filtered. Among other values this processor calculates RMS values and stores digitalized signal sequences to the memory and the signal recorder (option). Apart from data management and processing the DSP keeps performing wide-ranging self-tests.

### 4.4 Digital main processor

The main processor is the highest control element within the MRD1 and processes the actual protection program which interprets data obtained by the DSP and so refers to the operational status of the object to be protected and to the own device. Special protection mechanism enable the MRD1 to detect problems in the own hardware. All communication between MRD1 and the outside world is also controlled by the main processor. This does not only mean control of indications or handling of key inputs but also harmonizing the different data interfaces as well as control of output relays.

### 4.5 Block diagram

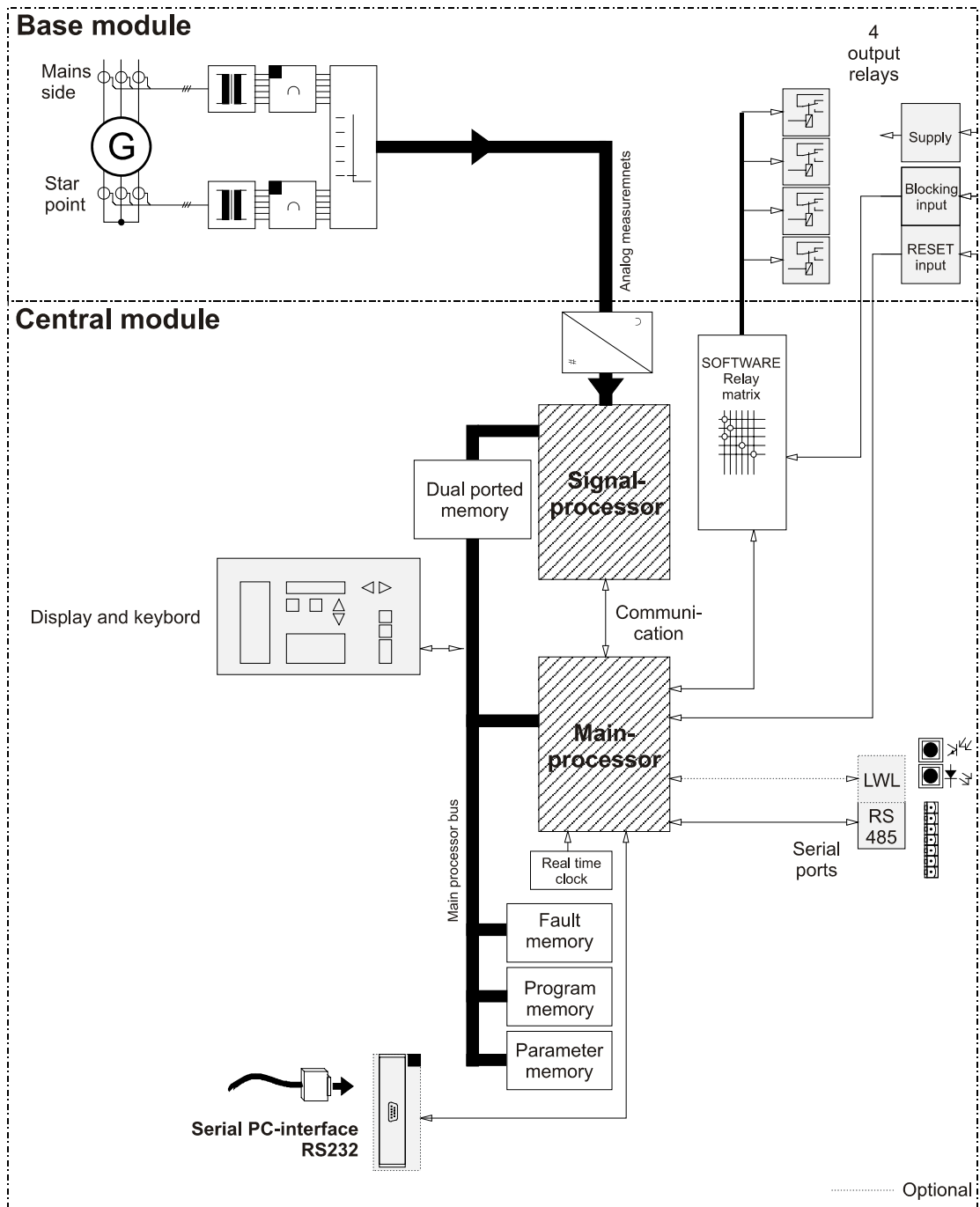

Figure 4.5: Block diagram

## 4.6 General functions

### 4.6.1 Event-Recorder

The MRD1 is provided with an event recorder for recording events in a chronological order and then stores them on a non-volatile memory. Any data entry has a time stamp so that time of the event can always be traced back. Data can be called off either via keys and display or data interfaces.

Important events, such as trippings, are not only recorded in the memory but also shown on the display. Pure informative events are stored in the recorder only and are not displayed.

More details on calling off events and further information on the event recorder can be found in chapter 5.

System messages are listed in chapter 9.1.

### 4.6.2 Fault-Recorder

At each tripping of the relays, the fault recorder records all measured data and resulting quantities. Any tripping event is automatically numbered consecutively in the recorder. Additionally to the measured data the following details are also stored: the cause for tripping, serial number of the incident as well as date and time at the instant of tripping.

The MRD1 is able to record several incidents in a FIFO memory. The longest stored data is overwritten when a new incident occurs. Complete data of altogether 5 incidents can always be called off.

More information on storage capacity and calling off recorder data via keyboard can be found in chapter 5.

### 4.6.3 -test relay

The self-test relay (relay 5) is energized during normal operation of the MRD1 and deenergized in the following events:

- failure of aux. voltage
- failure of internal partial power supply
- processor failure detected by the internal watchdog
- detection of an internal fault by software routines
- when protection function of the out-put relays is decoupled in OFFLINE TEST mode
- when the default parameter set was loaded and the device automatically switched in OFFLINE TEST mode
- self-test of the output relays is performed
- During power on initialization



#### 4.6.4 Self-test

By pressing the TEST key several menu guided special test routines can be started in the MRD1 for internal test purposes. Some tests disable the generator protection. These tests are locked by password.

The following tests and information can be performed/is available:

Test / Inquiry	Description	Password requested	Protection function
Software version number	Number of version and date of software are inquired	no	remains active
LED-Test	all LEDs light-up red f. 2s all LEDs light up green f.2s	no	remains active
Test of output relays	Sequence in one-second interval: self-test relay de energizes all other relays de-energize all relays energize one after the other (with LED) relays return to actual position self-test relay energizes	yes	inactive during the test
Memory test	Test of software and memory by checking the program check sum	no	remains active

#### 4.6.5 Output relay settings

##### Reset time of the output relays:

With the exception of the self-supervision relay, all existing output relays are assigned to the differential current element. It is possible to define a proper reset time for each individual relay. For this period - from the moment of tripping - the relay remains in trip condition even if the cause for the tripping does no more exist.

##### Note:

If the time for which the relay has been energized exceeds the adjusted reset time, the relay will release in-stantaneously after trip condition is cancelled. This is particularly important for relay tests (test of the reset time) where the test current is not switched off immediately with tripping.

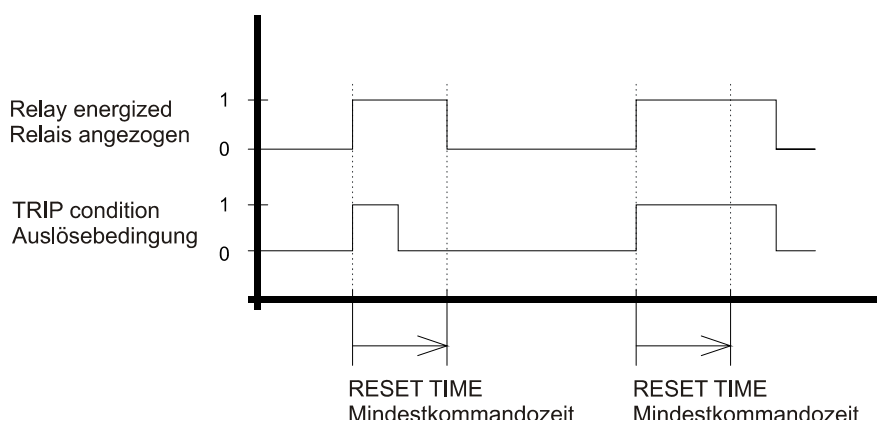

Figure 4.6.: Reset time

If a relay is to remain self-holding after tripping, the reset time has to be set to „exit“. Setting as per customer's requirements can be noted down in the „selection“ line.

Relay					
Basic equipment					
	1	2	3	4	5
Function	$I_{diff}$ $I_{diff} >>$	$I_{diff}$ $I_{diff} >>$	$I_{diff}$ $I_{diff} >>$	$I_{diff}$ $I_{diff} >>$	ST
Pre-adjustment (in s)	0.20	0.20	0.20	0.20	•
Custom setting					•

Setting range: 0 -...1,00 s or exit (=latching- contact until a DEVICE RESET is performed)

ST=Self-Test relay

• = no selection

#### 4.6.6 Parameterising blocking

##### Blocking of protective function

The MRD1 offers a configurable blocking function. When applying a voltage to terminals D8-E8 all protective functions are blocked that are configured for blocking. In case of active blocking the output relays don't act, but the device shows the fictive trip by means of Trip-LED.

A minimum hold time can be set for the blocking. During this time, starting from the begin of external blocking, all protective functions are blocked, also in case the external blocking may was released. In case of longer continuous external blocking the blocking can be stopped after a maximum hold time  $t_{max}$  for enabling the relay to trip in case of ongoing faults.

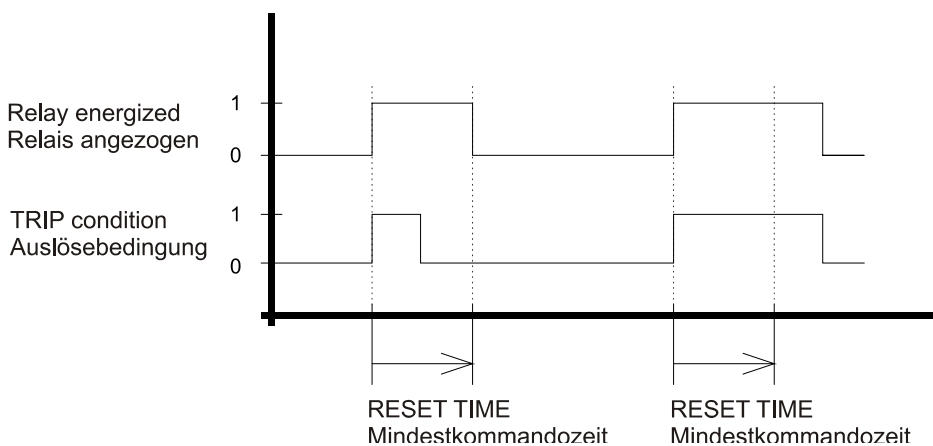

Note:

Repeated impulse at the blocking time within  $t_{min}$  restart the hold times.

##### Assignment of functions to output relays

The MRD1 offers 5 output relays. Relay number 5 is pre-assigned to the self test function of the relay and is working with zero-signal current principle. Output relays 1 – 4, and 6 – 10 are open-circuit relays and can be assigned to internal logic functions.

# 5. Operation

## 5.1 General

### 5.1.1 Data organization

Data and settings in the MRD1 are sub-divided into 4 groups and each of those are allocated to one menu key or key combination. Related parameters or measuring data of one group are combined on individual pages. General settings can be made on the SYSTEM parameter page. Test routines are also on separate pages.

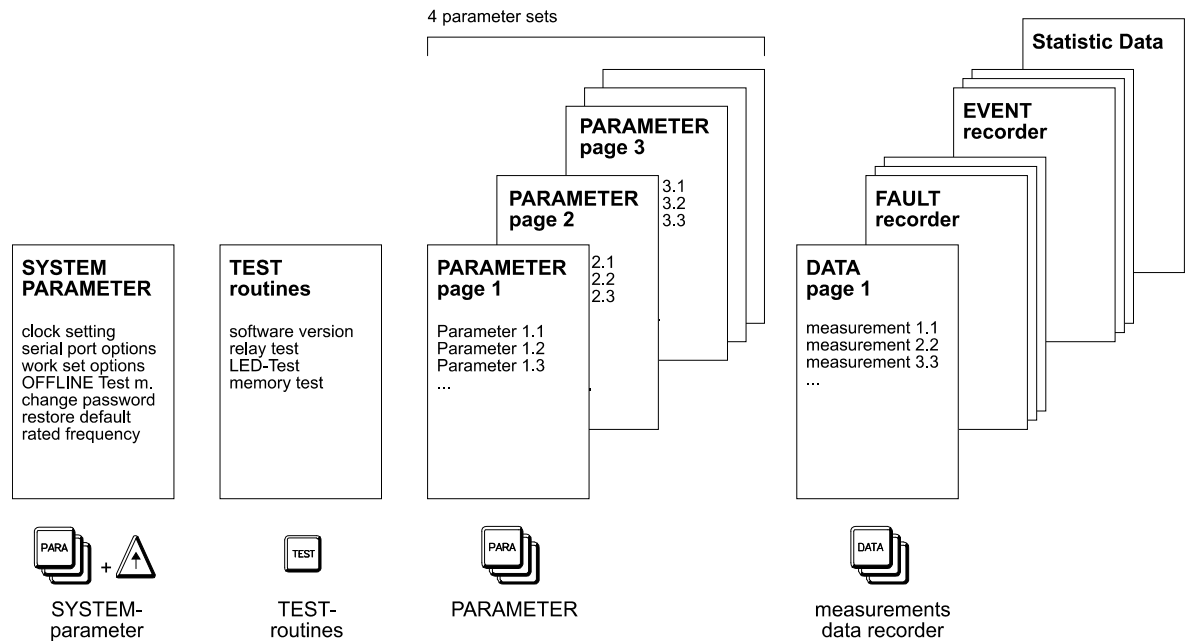

Figure 5.1: Data organization

## 5.1.2 Parameter sets

MRD1 has access to four independent parameter sets. Each of these data sets comprises a complete parameter set which makes individual setting of the MRD1 possible. If required by the operational procedure several different settings can be stored and then called off when needed. Data of SYSTEM parameters (e.g. rated frequency, slave address, date, time etc.) are not filled in the four parameter sets, they do always apply.

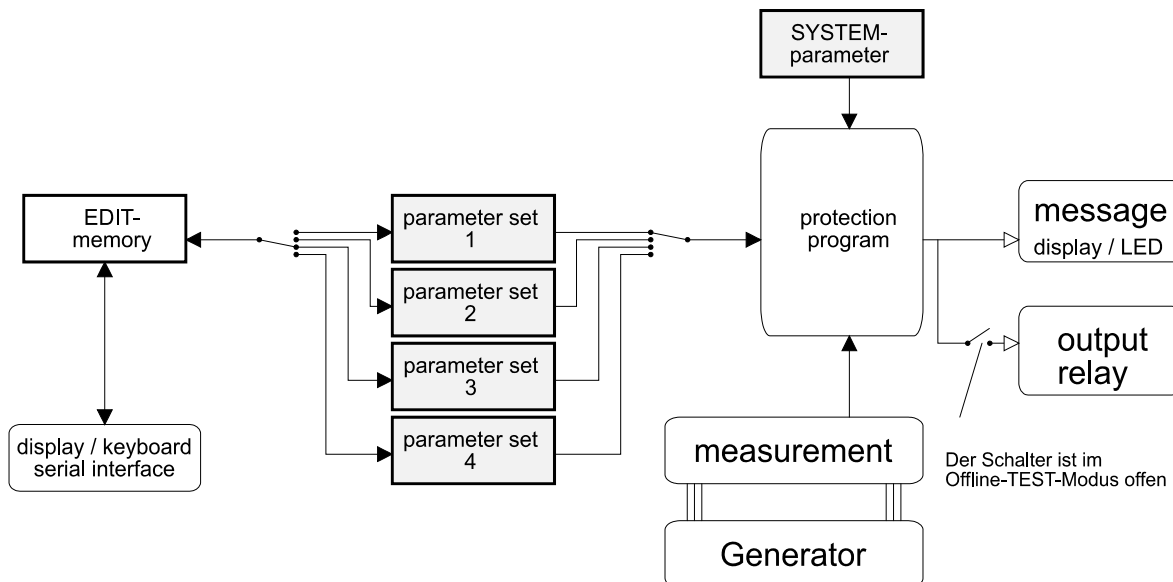



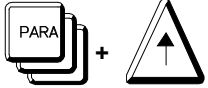

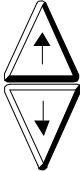
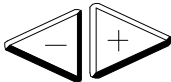

Figure 5.2: Parameter sets, principle

For processing the selected set is loaded into the EDIT memory (switch: Set to Edit). After parameters have been changed, the EDIT memory is completely restored in the parameter set memory. All changes are then jointly read-in.

Another switch (Work Set) defines on which of the data sets the protection program is based. All switches are adjusted via software.

OFFLINE TEST mode is specified in chapter 5.1.6.

### 5.1.3 Key function

Key	short actuated	long actuated (2s)
	a) from HOME POSITION: View active parameter set (VIEW mode)	from HOME POSITION: ① select one of the four parameter sets to edit (EDIT-mode)
	b) leaf to next PARA page	
	from HOME POSITION: ① select SYSTEM-parameter page	•
	a) from HOME POSITION: View DATA pages	•
	b) leaf to next DATA page	
	select the self test routines page	•
	scrolling up / down single step	scrolling up / down fast
	a) ① change value. single step b) move cursor	① change value, fast
	a) confirm selection (YES) b) toggle setting in EDIT mode (yes/no ; on/off)	finish working in EDIT mode, perform parameter plausibility check and save (if check passed) all modifications
	a) reject selection (NO) b) cancel modification c) clear message	a) From HOME POSITION DEVICE RESET b) From Sub-Menu back to home position

**Note**

In the following paragraphs key symbols are mainly used when explaining an operational procedure. Keys with the term "long" on them have to be pressed for about 2s for actuating the function. If there is nothing stated, the respective key has only to be pressed briefly.

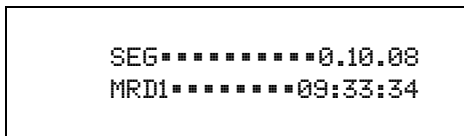
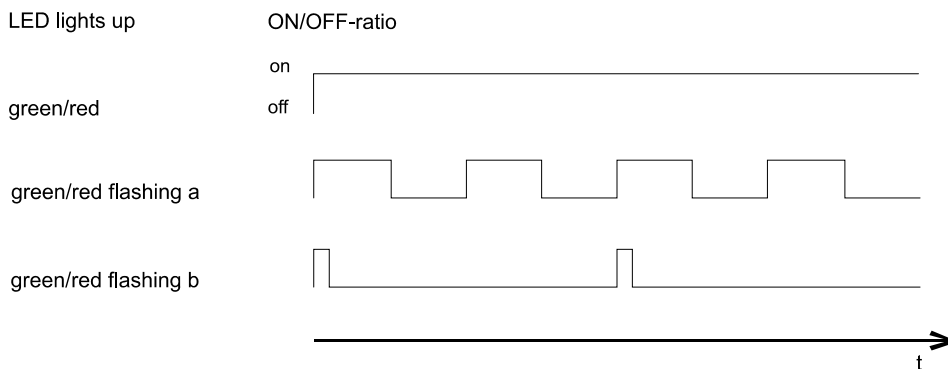

Figure 5.3: Display in HOME POSITION

## 5.1.4 LEDs

LEDs arranged at the relay front can light up in different colors and can also either show permanent light or flash in different frequencies.



### Meaning of the LED-signals

LED name	LED lights up	Meaning
POWER	green	Device OK
	red flashing a	FAULT of an internal supply
	off	Device OFF
TRIP	off	Normal
	red	Trip
	red flashing a	Energized
TEST	off	Normal
	red flashing a	OFFLINE-TEST-mode active
EDIT	off	Normal, VIEW mode
	red	EDIT mode after password access
MODIFIED	off	Normal
	red	EDIT mode: parameter modified
Relay	off	Relays off
	Red	Relays energised
	green	Relay-test
	red flashing b	Relay off after energising (until DEVICE RESET)
	red flashing a	Relay blocked
SELFTEST	green	Protection o.k. (selftest relay on)
	red	System initialisation (after power on)
	red flashing a	OFFLINE TEST mode / Relay-TEST. no protection, only messages
	off	Internal fault. no protection

### 5.1.5 VIEW mode / EDIT mode

There are two modes for selecting PARAMETER pages:

A short press on the PARA-key activates the VIEW-mode. The EDIT-mode can be selected by pressing the PARA-key for approx. 2 s (long press).

- **VIEW mode (viewing)**  
On pressing the key this mode only allows viewing the active parameters
- **EDIT mode (processing)**  
Unlike in mode VIEW, in EDIT mode one of the four parameter sets can be selected. That parameter set is then copied automatically into the EDIT memory and can be viewed there. At the first attempt of changing a parameter, the password is requested. After entering the password (LED EDIT lights up if the password was correct), the parameter can be changed. For any further change of parameter(s) the password is not requested again. In case the user does not know the password, the password entering mode can be cancelled and still parameter sets be viewed but as explained above, they cannot be changed.

It is not necessary to acknowledge any change separately by pressing the ENTER key since at first everything is processed in the EDIT memory only. Each of the changes can be cancelled again. LED MODIFIED indicates that the parameter displayed was changed. If it should be set back to the initial value, only brief actuation of key RESET (cancel function) is needed. If the process is closed (with: ENTER, long), all the changes can be rejected again or be accepted. (Checkback: ARE YOU SURE?). Before the parameter set is finally stored an internal plausibility check is performed to ensure that all settings are conclusive. If the check routine detects a irresolute combination of settings, the user will be informed and the settings are not stored. e.g. an unsuitable combination of generator rated current (which is calculated from rated voltage and power capacity setting) and the setted CT primary rated current.

The protection program executed in the MRD1 at the time is not affected by this procedure. Values of the active parameter sets filed in the PARAMETER memory are still being used until the complete EDIT memory is recopied into the respective PARAMETER memory. Only then all changes made taking effect together in the protection program.

#### Note

If during processing the aux. voltage fails, the complete EDIT memory is erased. After aux. voltage has returned, the protection program starts with those settings which were stored in the PARAMETER memory before the last processing operations. By this it is ensured that the protection program does not work with incompletely changed data or meaningless data.

If due to the continuously running check-sum test data error or loss of parameter memory is noted during start-up of the relay or during operation, a default parameter is loaded automatically. In such case the relay changes to the Offline mode (see next chapter) and the self-supervision relay de-energizes.

The EDIT-mode is left automatically if there is no input longer than 10 minutes (time out). Changed parameters will not be stored.

### 5.1.6 OFFLINE-TEST mode

For testing a parameter set the OFFLINE TEST mode can be activated. In this mode all output relays are being switched off. Now it can be changed over to another parameter set for testing without risking nuisance trip-ping. If the parameter set causes tripping, alarms are only shown on the MRD1 display or indicated via LEDs. The OFFLINE TEST mode is enabled or disabled on the SYSTEM SETTING page.

The OFFLINE TEST mode is indicated by:

- Self-supervision relay de-energizes (to inform the control system about the missing protection function)
- Self-supervision LED flashes red (= no protection)
- LED TEST flashes red (= TEST mode active)

#### Important Notes

To prevent an unintended trip the OFFLINE TEST mode is activated as de-fault setting on first commissioning. When the MRD1 recognizes a damaged parameter memory the default settings are loaded automatically and the Offline mode is activated (with selftest relay unenergized).

During OFFLINE TEST mode the generator is not protected by the MRD1. Although a failure could be detected during this mode, the MRD1 would not initiate a trip of the generator.

In order to prevent dangerous conditions, the generator must either have a sufficient backup protection or has to be switched off.

After an intended OFFLINE TEST this mode must be disabled so that protection is ensured again.

### 5.1.7 Reset (DEVICE RESET)

System messages in the display can be cancelled with a short press on the RESET key. The message is not removed at all but stored in the EVENT-memory. A trip will also cause a message which is also to be cancelled with a short RESET press. After this all measured and calculated values can be recalled from the fault recorder. All output relays and LEDs (if set to self-holding contact) will remain in energized position until a DEVICE RESET is initiated to the MRD1 by a long RESET press from home position.





The DEVICE RESET can also be initiated by the external reset input or via serial interface.

Info-messages do not need to be reset manually. They extinguish automatically after 5 s.



### 5.1.8 Enter password

The MRD1 calls for a password if parameters are intended to be changed in the memory or other important functions to be activated. Nearly all data can be called off by the user without entering a password, but for changing any data, the password is required. Some test functions can only be started after the password has been entered (see chapter 5.5).

If a password is required this is indicated on the display. The password consists of four digits and key combination, , , ,  has to be actuated.







Display	Process	Key
PASSWORD?	request to enter password	
PASSWORD? XX	entering password with every key press a further will appear in the display	   
PASSWORD CORRECT = 	password correct. LED EDIT on	
PASSWORD WRONG NO ACCESS = 	password incorrect LED EDIT remains off	

Table 5.1: Procedure for entering a password

 Message appears for app. 2 s

#### Note

Any process started can be stopped at any time by pressing key RESET:



The password entered at our works consists of key sequence

It is advisable to change this password immediately to an individual one.

LED EDIT indicates if the password entered is correct. In this state changes on MRD1 settings can be made. When changing over to another function in some cases the password has to be entered again.

Also after storing or cancelling, editing authority becomes invalid. Hence it is very important that the relay is only left after LED EDIT has extinguished to prevent unauthorized change of settings.

### 5.1.9 Password forgotten

#### Important

In case the password has been forgotten our works have to be contacted to inquire about the measures for regaining access.

## 5.2 SYSTEM settings

### 5.2.1 Selection

On this page the general functions are shown which are not stored in the four parameter sets. They are stored separately and always apply, irrespectively of the parameter set selected. The SYSTEM SETTINGS can only be selected from Home Display.

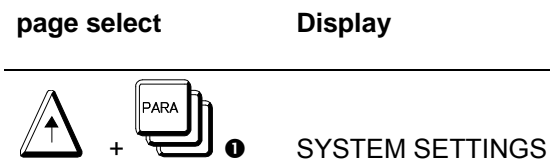

 Starting at Home Display: press UP and hold, press PARA in addition to, release both

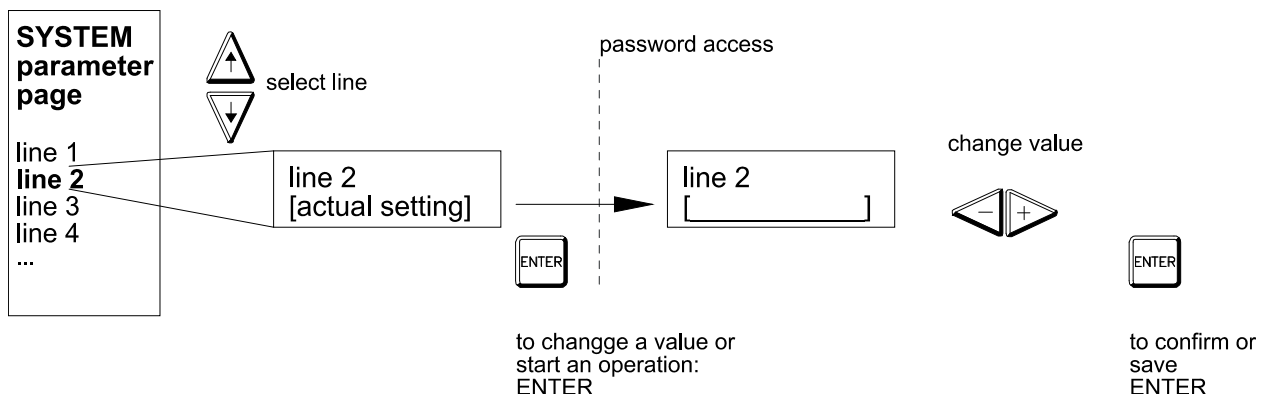

Figure 5.4.: System settings, principle

#### Note:

To change any setting or start an operation:

- Select parameter or option with UP / DOWN
- Press ENTER
- Enter password if requested
- If necessary: select setting with the +/- keys.

On setting date/time the arrow keys (up/down) are used to scroll to the next value.

Press ENTER to get new time valid.

## 5.2.2 Overview



Key	Existing lines	Settings	Range	Default	Actual setting
scroll  	-----SYSTEM----- ---SETTINGS-----	Headline			
	CHANGE DATE/TIME	change time and date	see 5.2.3		
	RATED FREQUENCY Fn= .. Hz	rated frequency in Hz	50 Hz 60 Hz	50 Hz	
	COMMUNICATION MODE = ...	select serial port	disable RS232 RS485CAN	RS485	
	SLAVE ADDRESSRS485	Slave-address of RS485-interface	1-32	1	
	GROUP ADDRESS CONFIG: .....	A...F Group selection t Time-/Date setting via serial interface	ABCDEFt <sup>2</sup>	. . . . t	
	EDIT PARA-SET VIA SP .....	programming via interface	enable disable	disable	
	SELECT PARA SET VIA SP .....	parameter set switch over via inter- face	enable disable	disable	
	OFFLINE TEST .....	ctivate Offline-TEST-Mode	enable disable	enable	
	SELECT WORK-SET SET (1) [ACTIVE]	select active parameter set	1 ... 4	1	
	PASSWORD CHANGE ROUTINE	change password	see 5.2.4		
	RESTORE DEFAULT SETTINGS	clear all parameter sets and set to default The device switches to OFFLINE TEST mode automatically!			
	CLEAR EVENT RECORDER	clear event recorder			
	CLEAR FAULT RECORDER	clear fault recorder			

Figure 5.5: SYSTEM settings page, overview

① Select with cursor and 

To change any setting or start an operation press  while shown in display.

### 5.2.3 Time / Date















Key	Display	Remark	Change value	Setting range
	CHANGE TIME / DATE	Headline	•	•
Scroll  	DATE: 01.01.____ TIME: 00:00:25	change year	 	1980-2099
	DATE: 01.__.1996 TIME: 00:00:25	change month	 	1-12
	DATE: __.01.1996 TIME: 00:00:25	change day	 	1-31 (depends on year/month)
	DATE: 30.01.1996 TIME: __:00:25	change hours	 	0-23
	DATE: 30.01.1996 TIME: 12:__:25	change minutes	 	0-59
	DATE: 30.01.1996 TIME: 12:00:__	change seconds	 	0-59
		accept settings and start new time / date	•	•
		cancel settings and restore old time / date	•	•

Table 5.2: Date /time-setting

- No selection possible

#### Note

Both arrow keys have the same function for this setting procedure. Both move the cursor always to the next digit group. After reaching the SECOND column, it is switched back to YEAR again. Digits for the year and month have to be entered before digit(s) for the day to enable the MRD1 to carry out correct calculation of intercalary days as well as the max. days in a month. The internal clock does not stop during the setting procedure so that when cancelled by RESET key the actual time is not changed. After pressing ENTER the modified time becomes valid.

Date/time setting may be synchronized via serial interface (see setting "GROUP ADDRESS).

## 5.2.4 Password change

The password in the MRD1 can be changed at any time. For changing a password it is necessary to know the present one. To rule out any typing errors, the password has to be entered twice. If the entries are not identical, the password is not changed and the previous one still applies. (Please see table below).













Display	Step	Key
PASSWORD CHANGE ROUTINE	Password change with ENTER	
TO CHANGE OPTION PASSWORD?	Request to enter old password	   
TYPE YOUR NEW PASSWORD!	enter new password	   
TYPE AGAIN NEW PASSWORD	enter new password again	   
PASSWORD CHANGED	🔔 changing done	
2 SIFF NEW PSW TRY AGAIN	🔔 The new password wouldn't be typed 2 times identically Try again	





Table 5.3: Password change, procedure

## 5.3 PARAMETER-pages

### 5.3.1 Selection

This table gives an overview about all pages of a parameter set and the parameters belonging to.

Select PARAMETER-pages in VIEW- or EDIT mode

Key	Display	Remark	
 short	VIEW PARAMETER SET (1) [ACTIVE]	VIEW active parameter set	continued at 5.3.2.
 long	LOAD SET TO EDIT SET (1) [ACTIVE]	EDIT mode select one of the four parameter sets to view or edit confirm with ENTER	 
	EDIT PARAMETER SET (2) [IDLE]	e.g. set 2 was loaded and is now ready for editing	continued at 5.3.2.

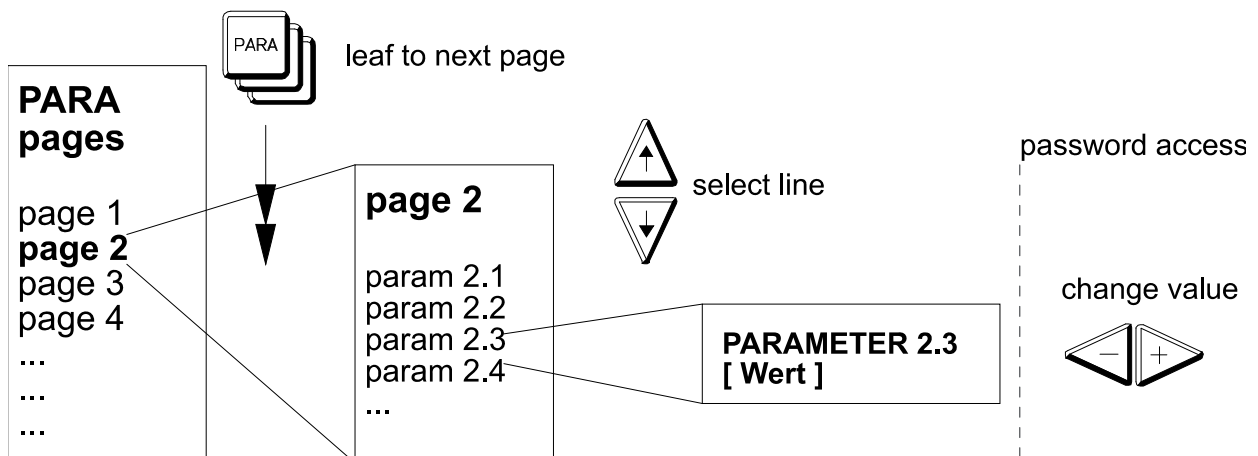

Figure 5.6: Parameter pages, organization

#### Possibilities after modifying a parameter:

- Keep modifications and scroll to next line (up/down)
- Keep modifications and leaf to next page (PARA short)
- Cancel modification of the displayed value (RESET short)
- Storage of changed parameters (ENTER long)
- Finish working and refuse all modifications, no store (RESET long)

### 5.3.2 Overview







Key	Pages Headline		Parameter	see
leaf to next page  	VIEW PARAMETER SET (↓) [ACTIVE] or EDIT PARAMETER SET (↓) [ACTIVE]	Parameter pages	active parameter ready for viewing (e.g. set 1) selected set ready for viewing and editing (e.g. set 2)	5.3.1
	***GENERATOR*** ***RATINGS***	Data of pro- tected device	Rated power Rated voltage CT primary current CT connection	5.3.3
	***PROTECTION*** ***SETTINGS***	parameter of differential- protection	Difference current at $I_s=0 \times I_n$ Difference current at $I_s=2 \times I_n$ Difference current at $I_s=10 \times I_n$ max. Difference current $I_{diff}>>$	5.3.4
	**OUTPUT RELAY** ***SETTINGS***	Parameter of logic functions	Assignment of protective and logic functions (AND-logic)	5.3.6
	*FUNCTION INPUT* *LOGIC SETTINGS		Reset time or self-holding of the output relay	5.3.5
	*EXTERN BLOCKING ***SETTINGS***	Parameter of external block- ing		5.3.7

Table 5.4: Parameter pages, overview

On the first attempt to change a set-ting with the ± keys in a edit session the password is asked. To view only parameter settings the PARA key is used to leaf to the next page and the UP/DOWN keys are used to select the parameter.

### 5.3.3 Generator ratings

Key	Display	Parameter	Select	Setting range (• no selection)	Default	Actual setting			
						1	2	3	4
	****GENERATOR*** ****RATINGS*****	Headline	none	•	•	•	•	•	•
	POWER CAPACITY SnWI = ... kVA	rated apparent current		10 kVA - 300 MVA	17.3 MVA				
	RATED VOLTAGE UnWI = ... A	rated voltage		100 V...30 kV	6.6 kV				
	CT PRIMARY In = ... A	rated primary current of CTs		1 A...50.000 A	1500 A				
	MA CT CONNECTION .....	Mains Side CTs connection in normal polarity (like connection diagram) or inverted (reverse polarity) ①		normal, inverted	normal				
SP CT CONNECTION .....	corresponding to Star Point CTs ①		normal, inverted	normal					

**NOTE:**

The Parameter must be set to inverted polarity, if the direction of current flow in the secondary circuit is reverse to the input terminals of MRD1 according to the connection diagram (Chapter 10).



### 5.3.4 Protection parameters

#### Differential protection

The tripping characteristic of the MRD1 can be set with four parameters:

$I_{diff0}$ : Error of the CTs

$I_{diff2}$ : Additional error of the CTs (linear range of the CTs)

$I_{diff10}$ : Additional error by saturation of the CTs

$I_{diff>>}$ : maximum permitted difference current

$d[I_d]$ : raise up of characteristic curve by offset in case of characteristic harmonics

$I_n$ : Generator nominal current (or motor nominal current)

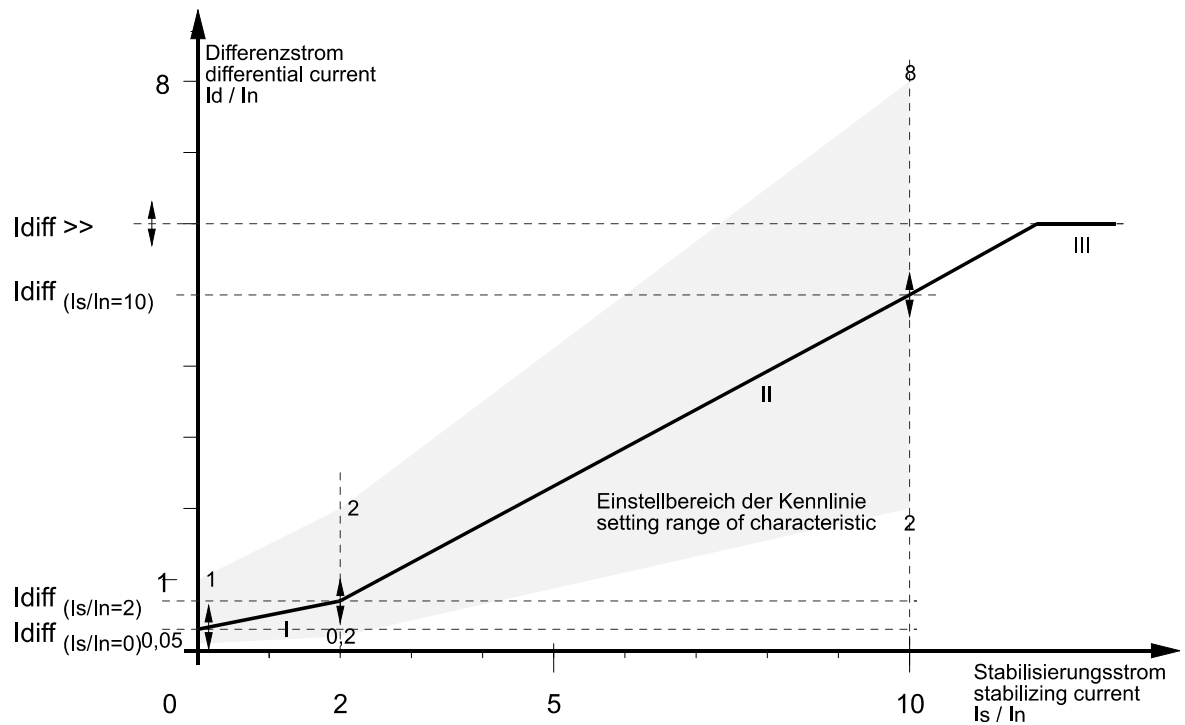

Figure 5.7: Possible setting range of the characteristic





Key	Display	Parameters of the characteristic	Select	Setting range (• no selection)	Pre-adjustment	Actual setting			
						1	2	3	4
	***PROTECTION*** ****SETTINGS****	Headline	none	•	•	•	•	•	•
	Idiff (Is=0xIn) = x.xx xIn	differential current Idiff at stabilising current Is/In=0 (see picture) ❷		0.05...1.0 × In ❶	0.2				
	Idiff (Is=2xIn) = x.xx xIn	corresponding to Is/In=2 ❷		0.2...2 × In ❶	0.4				
	Idiff (Is=10xIn) = x.xx xIn	corresponding to Is/In=10 ❷		2.0...8.0 × In	2.0				
	Idiff (High Set) Idiff>>=xx.xxIn	maximum permitted differential current		2.0...20.0 × In	4.0				
	**OFFSET VALUE** **d[Id]=x.x xIn*	Offset of characteristic curve from static basic characteristic curve		0.0...8.0	2.0				

Table 5.5: Adjustable protection parameter

❶ To get no negative slope in the characteristic part I the setting Idiff (Is=2) must not be less than the setting Idiff (Is=0). The MRD1 will check the inputs on this must.

❷ In = Generator nominal current (or motor nominal current)

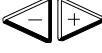
### 5.3.5 Relay-settings

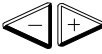









Key	Display	Setting	Select	Setting range (• no selection)	default	Actual setting			
						1	2	3	4
	**OUTPUT RELAY** ****SETTINGS****	headline	none	•		•	•	•	•
	RELAY 1 TO LOG. AB-----	Assignment of relay 1 to logic functions A...P, OR-logic	 [-]	ABC...P	AB...				
	RELAY 2 TO LOG. AB-----	corresponding to relay 2	 [-]	ABC...P	AB...				
	RELAY 3 TO LOG. AB-----	corresponding to relay 3	 [-]	ABC...P	AB...				
	RELAY 4 TO LOG. AB-----	corresponding to relay 4	 [-]	ABC...P	AB...				
	REL2 RESET TIME t(rst)= ... s	minimum Reset time /latching time for relay 1	 [-]	0.00 .... 1.00s /exit 	0.2 s				
	REL3 RESET TIME t(rst)= ... s	corresponding to relay 2	 [-]	0.00 .... 1.00s /exit 	0.2 s				

Table 5.6: Reset time of the output relays

 The reset time is the minimum time the relay keeps energized after a trip. If the time is set to exit the output relay is configured as a latching contact.  
The relay keeps energized after a trip until the MRD1 is RESETed. (DEVICE RESET)

### 5.3.6 Setting of logic functions

Key	Display	Setting	Select	Setting range (● no selection)	De- fault	Actual setting			
						1	2	3	4
	*FUNCTION INPUT* *LOGIC SETTINGS*	Header line							
	<F> INPUT LOGIC A TO FUNCT: A-	Assignment of logic functions A to protective functions (here: protective function A = Id>)		A...B	A_				
	<F> INPUT LOGIC B TO FUNCT: -B	Assignment of logic functions B to protective functions (here: protective function B=Id>>)		A...B	_B				
	<F> INPUT LOGIC C TO FUNCT: AB	Assignment of logic functions C to protective functions (here: protective function A and B)		A...B	—				
	...			A...B	—				
	<F> INPUT LOGIC P TO FUNCT: AB	Assignment of logic functions P to protective functions (here: no protective function)		A...B	—				

#### Note

For MRD1 there is the following definition:



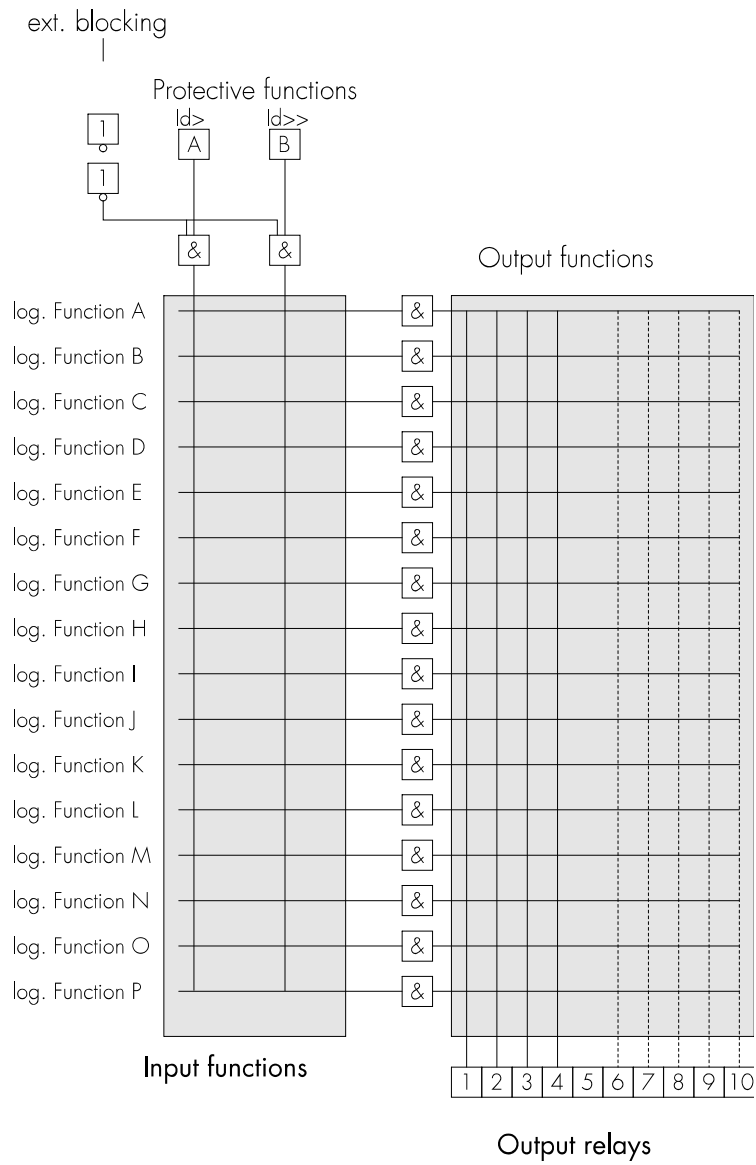

Protective function A: Differential protection Id> (Low Set)

Protective function B: differential protection Id>> (High Set)

**Scheme:**



### 5.3.7 Blocking Setting

Key	Display	Setting	Select	Setting range (• no selection)	Default	Actual setting			
						1	2	3	4
	EXTERN BLOCKING ****SETTINGS****	Header Line							
	EXTERN BLOCK TO* FUNCTION = AB**	Blocking of protective functions (here: protective function A and B)		--,AB	AB				
	EXT. MIN BL-TIME t-min = 0.1 s	Min hold time of blocking «exit»:no min. hold time		0.0 ... 60.0 exit	0.1s				
	EXT. MAX BL-TIME t-max = 2.0s	Max. blocking time when continuing blocking signal «exit»: latched as long as signal holds		0.1 ... 60.0 exit	2.0s				

### 5.3.8 Validity check

The MRD1 is provided with a special parameter checking facility as protection against wrong settings. However, to prevent that the actual setting range is too much restricted, this facility can only protect against gross setting errors. Before they are stored, changed settings are checked for their mutual validity. The procedure is such that firstly the parameters are compared to the calculated rated currents  $I_N$  (per winding) of the component, which result from the rated apparent power and rated voltage. Thereafter inter-relation of the parameters is checked.

If there is a discrepancy when setting parameters via the keyboard, either the MRD1 does not allow the respective value to be further changed or refers to the inconsistent value by issuing a clear text message when trying to store the parameter. In this case the EDIT mode is not left and the value can be corrected.

When setting parameters via an inter-face, validity errors are indicated by a special telegram message.

A setting is not regarded to be valid if one of the following conditions are not met :

CT mismatch for each winding  $1/4 \times I_N < I_{WPN} < 2 \times I_N$

- CT transformation ratio at MRD1 rated current  $I_{WPN} < 5 \text{ A}$
- Relation of voltage levels For three-winding transformers (MRD1-T3)  
 $U_{N \text{ Winding } 1} \geq U_{N \text{ Winding } 2} \geq U_{N \text{ Winding } 3}$   
 For two-winding transformers (MRD1-T2)  
 $U_{N \text{ Winding } 1} \geq U_{N \text{ Winding } 2}$
- Tripping characteristic  
 $I_d(I_S=0) \leq I_d(I_S=2)$   
 i.e. gradient<sub>Sector I</sub>  $\geq 0$   
 and gradient<sub>Sector I</sub>  $\leq$  gradient<sub>Sector II</sub>
- Ext. Blockage  
 $t_{\min} > t_{\max}$   
 minimum hold time is greater than maximum hold time

#### Abbreviations:

$S_N$	set rated vector power
$U_N$	set rated component voltage (phase-to-phase voltage)
$I_N$	rated component current ( $I_N = S_N / (\sqrt{3} \times U_N)$ ) calculated from $U_N$ and $S$
$I_{WPN}$	set rated C.T. primary current
Gradient	characteristic gradient in the respective linear sector (see chapter 5.3.4)

## 5.4 DATA pages

### 5.4.1 Selection

All measured, calculated and stored data can be recalled on the data pages

Key	Display
	--DATA READING-- ---PROCEDURE---

Figure 5.8: Data pages, organization





## 5.4.2 Overview

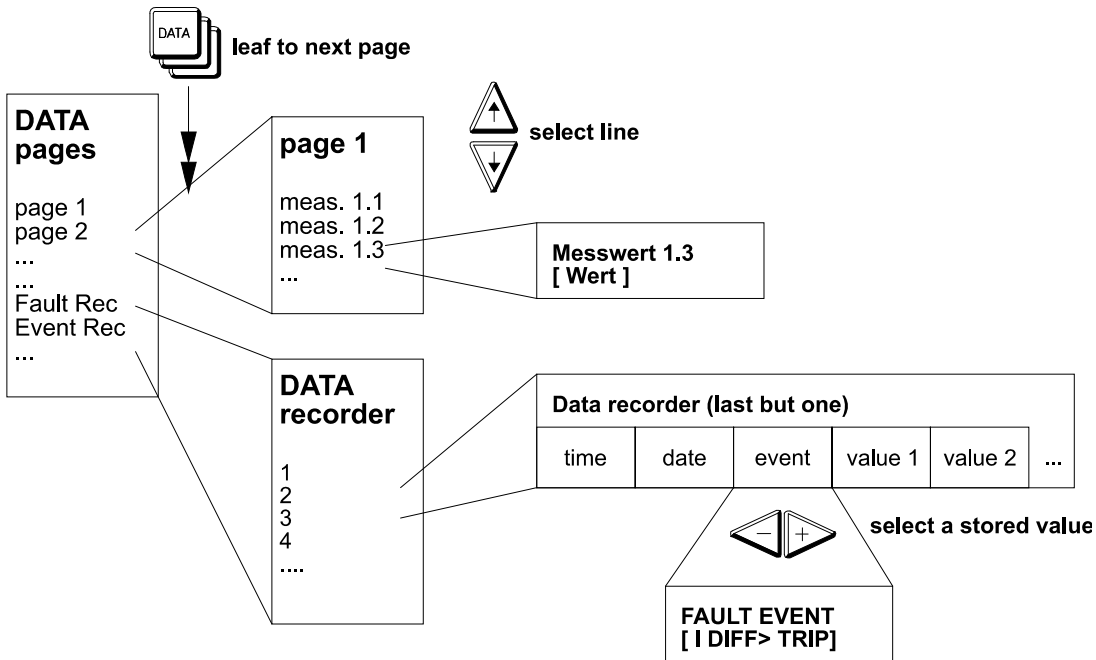



Key	Page Headline	Data	
leaf to next page 	--DATA READING-- ---PROCEDURE----	Data pages selected	
	**OPERATIONAL** **MEASURED DATA*		Actual measurements and calculated dates Phase current (L1 L2 L3) Differential current Stabilising current Is
	*FAULT RECORDER* *****DATA*****		Recall stored trip dates Trip message, date / time , measurements calculated measurements
	*EVENT RECORDER* *****DATA*****		Recall event messages Message text date / time
	***STATISTIC*** *****DATA*****		Recall statistic Data Operating hours Trip counter Alarm counter

Table 5.7: Data pages, overview

## 5.4.3 Measured and calculated data

Key	Display	Data
Scroll 	OPERATIONAL MEASURED DATA	Headline
	MEASURED CURRENT I MA L1 ....A	Actual measuring value of the phase current L1 MA=Mains side in A
	MEASURED CURRENT I MA L2 ....A	corresponding to L2
	MEASURED CURRENT I MA L3 ....A	corresponding to L3
...	etc.	Phase current in A (SP=Star point side) calculated difference current (Idiff) calculated stabilising current (Irestr)

Table 5.8: Operational measured data

## 5.4.4 FAULT Recorder









Key	Display	Value	
Scroll 	*FAULT RECORDER** *****DATA*****	Headline	
	FAULT RECORDER REGISTER (0)	 see below	Record 0 (last trip) Trip number date/time trip reason, all stored data
	FAULT RECORDER REGISTER (1)		Record 1 (last trip but one) Trip number date/time trip reason, all stored data
	for all existing registers		Record n in chronological order Trip number date/time trip reason, all stored data

Table 5.9: Data of a fault recorder

Key	Display	Value	
next value 	FAULT RECORDER REGISTER (0)	Headline of the last trip (e.g.)	
	FAULT NUMBER Nr. XXXX	Trip number	
	FAULT EVENT XXXXX XXXXX	Reason of the trip	
	FAULT DATE xx.xx.xx	Date of trip	
	FAULT TIME xx:xx:xx:xx	Time of trip	
	FAULT CURRENT W1 L1: xxx A	Current L1 of winding 1 in A	
	etc.	corresponding for all stored dates	

### 5.4.5 EVENT-Recorder

Key	Display	Value
Scroll 	*EVENT RECORDER* *****DATA*****	headline
	EVENT Nr: 0 .....	 Event 0 see below event message- date/time of the last event
	EVENT Nr: 1 .....	 Event 1 event message- date/time of the last trip but one (previous)
	corresponding to all stored events	 Event n event message- date/time in chronological order

Key	Display	Value
next value 	EVENT NUMBER (1) .....	Event number and event e.g. last event message
	EVENT DATE: 01.01.90	Date of event
	EVENT TIME: 12:23:34	Time of event

Table 5.10: Message and time / date

### 5.4.6 Statistic data

Key	Display	Value
next value 	***STATISTIC*** *****DATA*****	Headline
	TOTAL RUN TIME ... h	MRD1 Operating hours
	TOTAL NUMBER OF TRIPS: ...	Trip counter
	TOTAL NUMBER OF ALARMS: ...	Alarm counter

Table 5.11: Statistic data

#### Note

This statistic counters cannot be resetted.



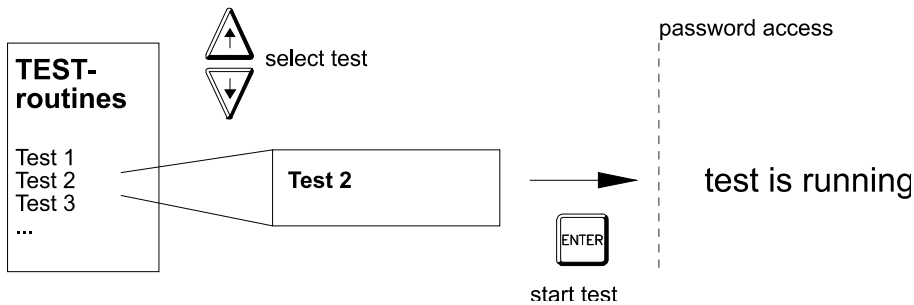

## 5.5 TEST-routines page (Self-test)

### 5.5.1 Page selection

Page select	Display
	*INTERNAL TEST** ****ROUTINES****



### 5.5.2 Overview









Key	Test	Description	execute
scroll	*INTERNAL TEST** ****ROUTINES****	Headline	
	VERSION:xxx-x.xx DATE: XX.XX.XX	Display of version and date of the software	Display only
	LED FUNCTION SELF TEST	Test Test of the LEDs: all LEDs will be illuminated green and red for two seconds (no password needed)	
	OUTPUT RELAY SELFTEST	Test Test of the output relays: IMPORTANT: all relays will be energised in a 1 s interval. The self test Relay keeps off for the duration of the test. After the test all relays will be set to the state before	
	PROGRAMM DATA CHECKSUM TEST	Test Memory/program test: This routine will test the memory and the program by calculating a checksum.	



❶ NOTE: Password is needed, because the protection function is disabled during the test!

Table 5.12: Implemented test routines

## 5.6 Parameter programming help

This chapter is a step by step help how to enter the first specific settings into the MRD1 by keyboard. For more information about the parameter and its setting ranges see chapters: PARAMETER-pages and SYSTEM settings.

Step	Key
1 select PARAMETER-page in EDIT-mode	 long
2 if necessary: select the set No. to edit	
3 confirm selection (set will be loaded in EDIT memory)	
4 leaf to first parameter page	
5 scroll to the first line of this page (first parameter)	
6 if necessary: change displayed value	
	on first modification: enter password For bit-wise parameter like system-parameter "Group Address" press [-] shortly
7 scroll to next line (second parameter)	 there is no need to confirm the modification of step 6 with a separately ENTER press.
8 if necessary: change displayed value	repeat step 6 and 7 as long as needed
9 leaf to next page	 continue at step 5

Other operations	Key
finish working and store all modifications (EDIT-memory will be copied back to parameter memory)	 long
abandon working and refuse all modifications (no storing)	 long
cancel modification on the displayed parameter and reset to old value. (if LED MODIFIED illuminated)	 short
edit another parameter set	finish with ENTER long or RESET long and continue on step 1

### Note

There is no need to confirm any modification by pressing ENTER. All modifications are temporarily stored in the edit memory when scrolling with up/down keys. When pressing ENTER long all modifications in the edit memory will be stored in the parameter set memory after an ensurance request.

## 6. Relay Tests

For testing the MRD1 the following has to be taken into account:

The test current source must supply a current free of harmonics. Should this not be the case, measuring errors may result from this if the reference ammeter used is an RMS instrument (which is common practice).

	A	B	C	D
$I_{diff}$	$2/3 \times I$	0	$1 \times I_n$	0
$I_s$	0	$2/3 \times I$	0	$1 \times I_n$

Value indications dependent on the test circuit used

Test circuits for differential current  $I_{diff}$  and stabilizing current  $I_s$ :

The rated value indication for differential current and stabilizing current can be gathered from the following table. Test current  $I$  should be in compliance with the generator nominal current (or motor nominal current).

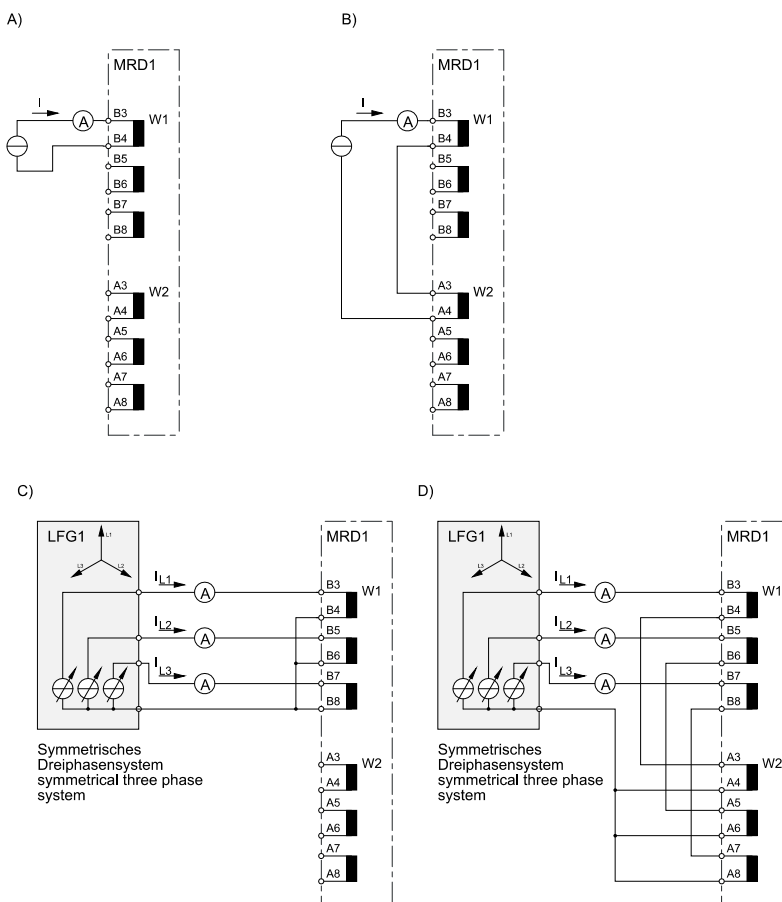

W1= Mains side, W2 = Star point side, LFG= (e.g.) Woodward Power Function Generator

### NOTE for relay tests:

- Stated accuracies apply to rated values
- Currents must be free of harmonics
- When a three-phase connection is used for the test, the current must form a symmetric system
- Parameters MA CT connection and SP CT connection must be in normal position

## 7. Commissioning

### 7.1 Check list

Check	Remark	ok. ?
Safety Measures	Observe relevant safety regulations	
Aux. voltage range	Prior to connection it has to be checked whether existing aux. voltage is within the permissible range for <i>MRD1</i>	
Rated system data	Secondary currents of CTs provided in the system have to be in compliance with rated currents of the <i>MRD1</i> (1A or 5A) in the respective winding	
Connection	Check <i>MRD1</i> for correct connection in the switchboard	
Entry of rated system data	Has all rated system data correctly been programmed ? Are the indices of the vector group setted. Are the CTs connected normal or revers	
Setting of parameters for protection	Have all parameters for protection correctly been programmed ?	
Reset time	Are the reset times set to all output relays?	
Selection of work parameter set	Has the right parameter set been selected as working set?	
Protection function	Does LED SELF-TEST light up green and is self test relay energized ?	
Device tests	Self test routines - Lamp test - Test of the output relays - Checksum test - Test of the working parameter set in OFFLINE TEST mode	

### 7.2 C.T. connection

The right polarity of the C.T. is very important and so when the MRD1 is initially connected this has to be checked carefully. Reverse polarity at even one C.T. only is likely to cause trip errors. Whether connection of the MRD1 is correct can roughly be seen from the differential current indication, provided the object to be protected operates trouble free. To check the correct C.T. connection, firstly the MRD1 should be operated at the object to be protected in OFFLINE TEST mode.

#### Important Note:

In this operational mode, the object to be protected must have a sufficient back-up protection. Furthermore it is assumed that the supervised component is not faulty and all parameters are correct. When in OFFLINE TEST mode it is ensured that a CT with perhaps reverse polarity does not cause an unintended trip.

Now the supervised component can be switched on while observing and interpreting the differential current indication. Interpretation of the indicated value is always subject to local conditions (operation related fault current) and can here only be described generally. The test circuits described in chapter 6 can be of help for fault identification.

The following table can be considered as reference when checking the connection. The stated values are based on symmetrical load  $I=I_{L1}=I_{L2}=I_{L3}$ . Where loads are involved which are not 100 % symmetrical, the observed values may deviate from the table. All figures are to be understood as approximate values and are a multiple of the load current.

Case	Differential current $I_{diff} / I_n$	Through current $I_s / I_n$
1 All CTs are correctly connected	0	1
2 One CT connect. with rev. polarity	1,33	0,66
3 Two CTs connect. with rev. polarity	2,0	0
4 Three CTs connect. with rev. polarity	2,0	0

Table 7.1: Recommended values for differential current and stabilizing current indication at the MRD1 with assumed faultless components and different numbers of CTs connected

### 1) Correct connection:

All C.T.s are correctly connected. This case is identical to that where all C.T.s are wrongly connected or the direction of energy flow is reverse. But changes at the C.T. connection are not necessary.

### 2) One C.T. wrongly connected

In this case the current balance is out of place. There is about  $1/3 \times I$  through current missing and the MRD1 recognizes  $2/3 \times I$  differential current instead. Input and output currents in the phase with wrong polarity are interpreted by the MRD1 that way as if  $1/3 \times I$  each flow into the faulty phase. Thus the resulting differential current is  $2/3 \times I$ .

### 3/4 Two or three C.T.s wrongly connected

In these two cases the indication does not distinguish between two or three C.T.s wrongly connected because of the internal calculation. If three CTs are wrongly connected, the respective fault can be eliminated by changing parameter "C.T. Connection" without having to change the wiring

For locating all other faults either the complete C.T. wiring has to be checked after disconnection of the component or the reversed connections to be traced by means of a suitable test current source.



## 8. Technical Data

### 8.1 MRD - G Generator Differential Protection Relay

#### Common data

Rated frequency:	50 Hz, 60 Hz		
Display:	LED and LCD-Display (2 x 16 digits)		
Voltage supply			
Aux. voltage ranges	Range	Rated voltage	Range
DC	L	24 V	19-40 V
	M	48/60 V	38-72 V
	H	110/125/220 V	88-264 V
AC	on request		
Power consumption	stand-by	13 VA	
	maximum	16 VA	
Permissible interruption of the auxiliary voltage supply	max. 50 ms (at rated voltage)		
<b>Input CT</b>			
<b>a) Phase current CT</b>			
Rated current $I_N$	1 A or 5 A		
Power consumption in current path:	at $I_N$ < 0.1 VA		
Thermal withstand capability in current circuit:	250 x $I_N$ (VDE 435, T303), dynamical current withstand (half-wave) 100 x $I_N$ for 1 s 30 x $I_N$ for 10 s 4 x $I_N$ continuously (VDE 435, T303)		
linear range	Low-Range	0.05...2 x $I_N$	
	High-Range	2...64 x $I_N$	
Range setting	automatically		
Resolution	12 Bit per range		
Failure	< 0.1 % at $I_N$ < 0.1 % at 64 x $I_N$		
Accuracy (related to the measured value)	0.05x $I_N$	<2%	
	1x $I_N$	<1%	
	15x $I_N$	<2%	
Operating time	25-30 ms		
C.T. requirements:	recommended min. requirements to exposit device accuracy 5P20		

## Function- and signal inputs

### Digital inputs

Thermal withstand capability	max. 310 V DC, 265 V AC
Coupling	galvanically isolated with common return wire
High-level	U > 18 V DC/AC
Low-level	U < 12 V DC/AC

### Reset and blocking input

Thermal withstand capability	max. 310 V DC, 265 V AC
Coupling	galvanically isolated with common return wire (D8)
High-level	U > 18 V DC/AC function activated
Low-level	U < 12 V DC/AC Function not activated

### Communication serial interface RS232C

Data transmission rate	9600 Baud
Connection	9-pin D-sub plug
Insulation voltages	DIN 19244 part 3 (IEC 870-3):

### RS485

Data transmission rate	9600 Baud
Connection	plugged terminals (RXT/TXD-P, RXT/TXD-N, Signal Ground, PE)
Insulation voltages	DIN 19244 part 3 (IEC 870-3):

### Output relay

Contact class	IIB DIN VDE 435 part 120
max. breaking voltage:	250 VAC/300 VDC
max. closing power:	1500 VA (250 V)
max. breaking power:	11 VA (220 VDC) at L/R = 40 ms
max. rating making current:	6 A
Short circuit current:	20A/16 ms
Rated inrush current load:	64A
Returning time:	20 ms (without minimum operating time!)
Contact material:	AgCdO
Contact life span:	electrical: 2x10 <sup>5</sup> switching points at 220V AC / 6A
mechanical:	30x10 <sup>6</sup> switching points
Rated insulation voltage:	600 VAC (450V DC / 380 VAC) (VDE 435, T303) Air- and creeping distance VDE 0160
Insulation coordination:	pollution degree 3 for terminals, pollution degree 2 for the electronic

Insulation test voltage, inputs and outputs between themselves and to the relay frame as per IEC 255-5: 2.0 kV (RMS.)/50 Hz.; 1 min.

Impulse test voltage, inputs and outputs between themselves and to the relay frame as per IEC 255-5: 5 kV; 1.2/50  $\mu$ s, 0.5 J

High frequency interference test voltage, inputs and outputs between themselves and to the relay frame as per IEC 255-22-1:	2.5 kV/1 MHz
Electrical discharge (ESD) test as per VDE 0843, part 2 IEC 77B(CO)21; IEC 255-22-2:	8 kV
Electrical fast transient (Burst) test as per DIN VDE 0843, part 4 IEC 77B(CO)22; IEC 255-22-4:	4 kV/2.5 kHz, 15 ms
Radio interference suppression test as per EN 55011:	limit value class B
Radiated electromagnetic field test as per ENV 50140:	electric field strength: 10 V / m
Power frequency magnetic field immunity test IEC 1000-4-8 (EN 61000-4-8):	100 A/m continuous 1000 A/m 3 s
Surge immunity test (asymmetrical / symmetrical) IEC 1000-4-5 (EN 6100-4-5):	4 kV
Mechanical test: Shock: Vibration: Degree of protection: Overvoltage class:	Class 1 as per DIN IEC 255 T 21-2 Class 1 as per DIN IEC 255 T 21-1 Front IP40 III
Setting ranges:	s. tables chapter 5 and 10

## 9. Tables/Connection diagrams

### 9.1 Possible event messages

Display	Event
change to Pset x	Parameter set x is selected to active working set
UART Paramet. on	Parameter setting via interface is active
UART Paramet. off	Parameter setting via interface is not permitted
deflt. para. load	Default parameter settings reloaded
manual reset	Manual DEVICE RESET is performed
external reset	External DEVICE RESET is performed
ser. port reset	Software DEVICE RESET is performed
ext. block begin	Blocking feature activated by external input
ext. block end	End of blocking
Idiff> tripped	Difference current trip
Idiff> released	Difference current trip released
Idiff>> tripped	Difference current high-set trip
Idiff>> released	Difference current high-set trip released
relays operated	Change output relay state (except Self test relay)
ST-relay eners.	Selftest relay is energised
ST-relay release	Selftest supervision relay is deenergized
LED-Test done	Lamp test is finished
relay-test done	Test of the output is finished
self-test done	Self-test is finished
offline mode en	Offline-Test-Mode is active
offline mode dis	Offline-Test-Mode is not active
fault rec clear	Fault recorder is cleared
event rec clear	Event recorder is cleared
System start	System start / device initialisation
old time settings	Time/date setting was changed (old time)
new time settings	Time/date setting was changed (new time)

## 9.2 View

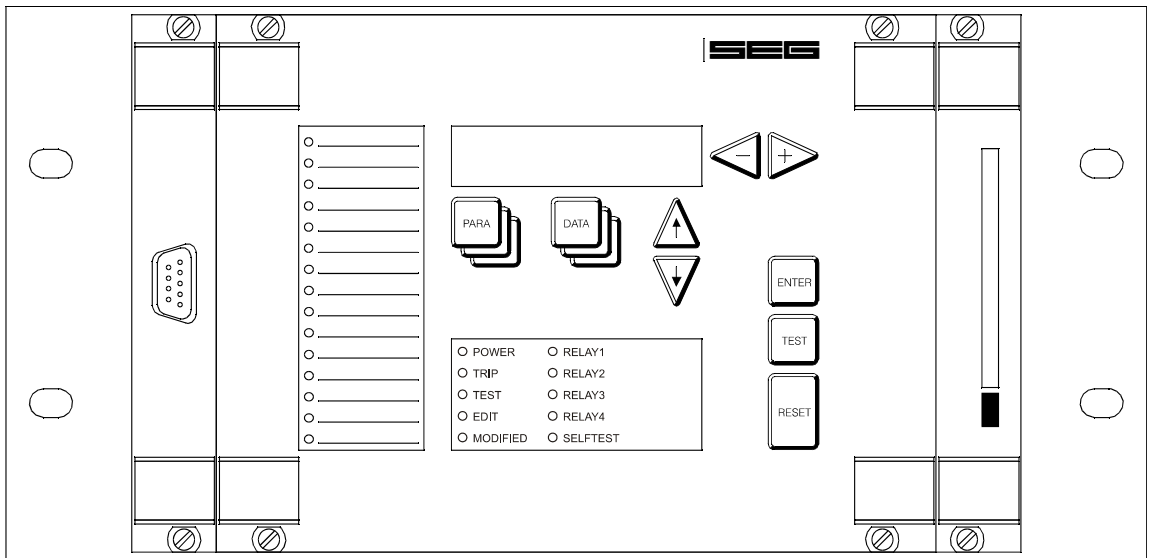

### Front plate:

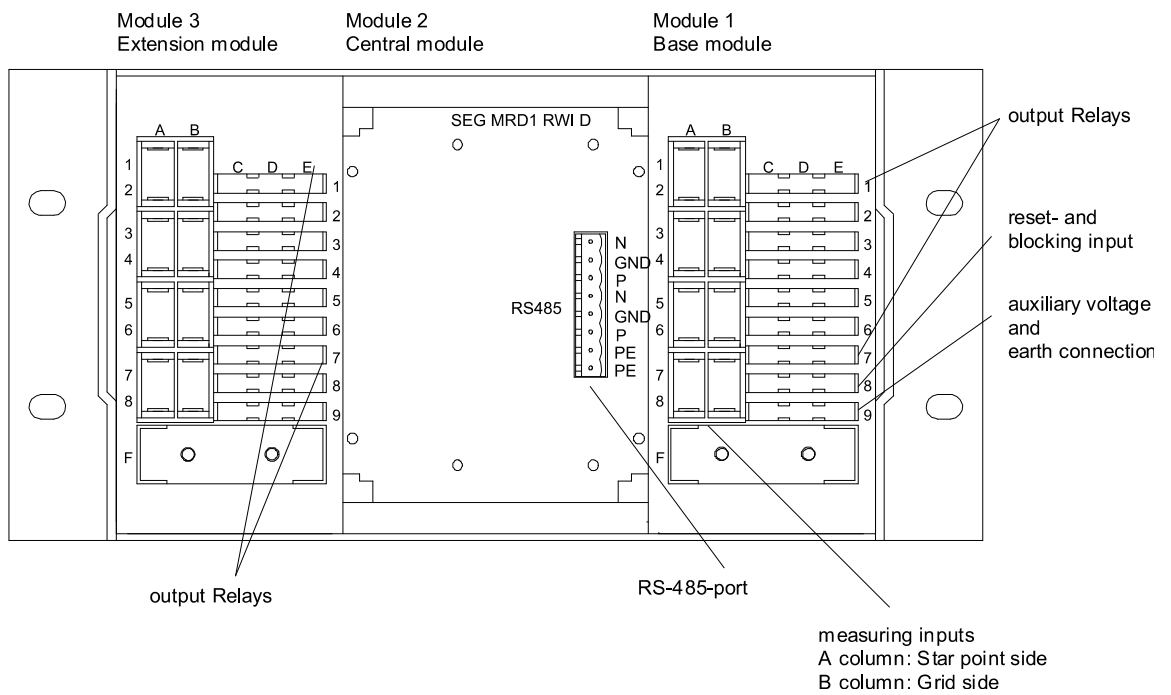

Rear plate

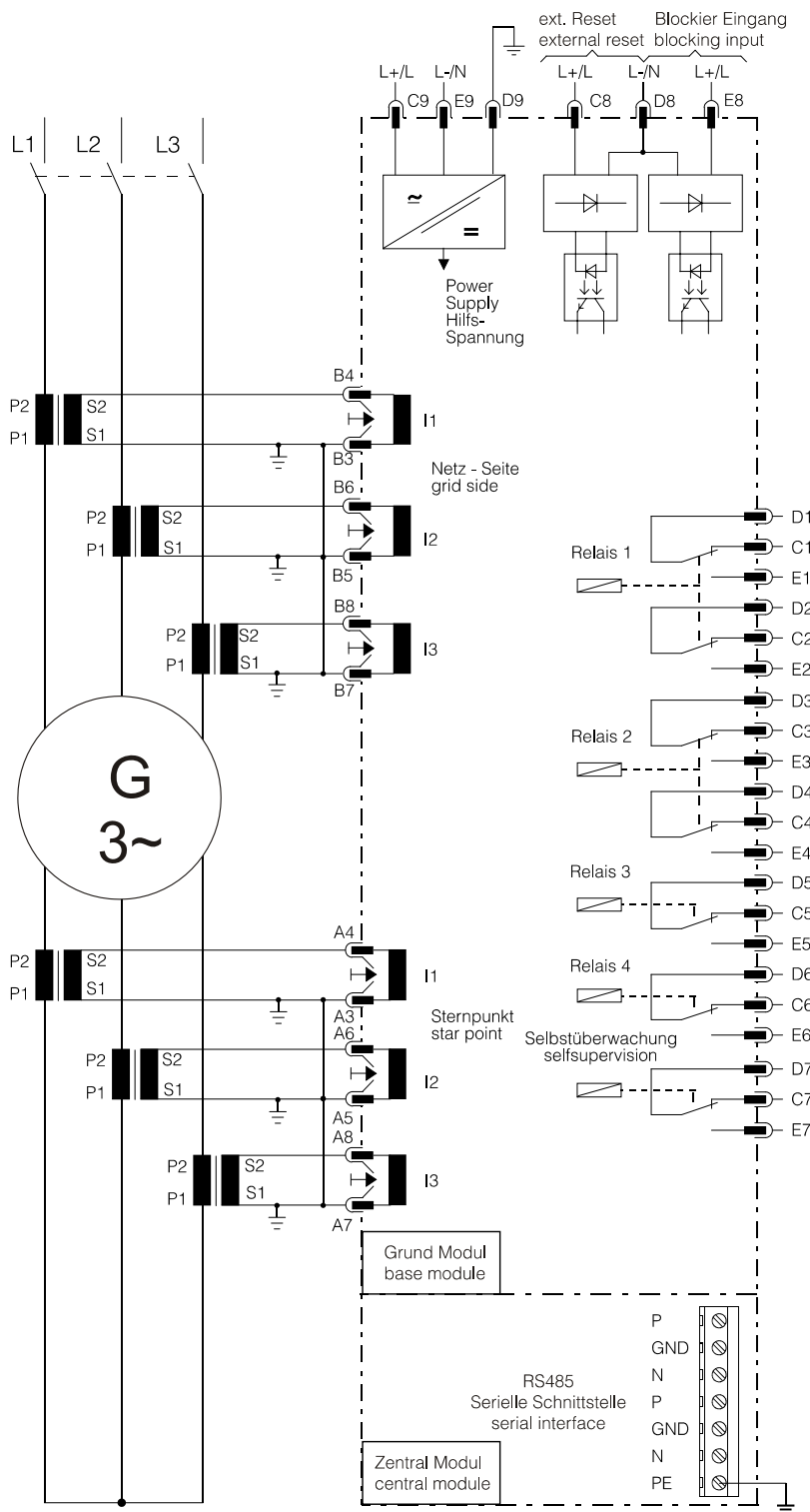

Table 9.1.: Connection diagram MRD1-G

Technical data subject to change without notice !

## 10. Order form

Generator – differential protection relay	<b>MRD1-</b>			<b>A</b>
Rated current 1 A 5 A		<b>G1</b> <b>G5</b>		
DC-auxiliary voltage 24 V (19 to 40 V DC) 48 V/60 V (38 to 72 V DC) 110 V/125 V/220 V (88 to 264 V DC)			<b>L</b> <b>M</b> <b>H</b>	
Housing (42TE) additional MRD1-T2-HTL-3F42 available ❶				

❶ necessary rack for the single components

### Note

Normally the MRD1 is provided with one type of current transformer only (1A or 5A). Equipment with two CTs of different current ratings in one relay only on request.

**Woodward Kempen GmbH**

Krefelder Weg 47 · D – 47906 Kempen (Germany)  
Postfach 10 07 55 (P.O.Box) · D – 47884 Kempen (Germany)  
Phone: +49 (0) 21 52 145 1

**Internet**

[www.woodward.com](http://www.woodward.com)

**Sales**

Phone: +49 (0) 21 52 145 216 or 342 · Telefax: +49 (0) 21 52 145 354  
e-mail: [salesEMEA\\_PG@woodward.com](mailto:salesEMEA_PG@woodward.com)

**Service**

Phone: +49 (0) 21 52 145 614 · Telefax: +49 (0) 21 52 145 455  
e-mail: [SupportEMEA\\_PG@woodward.com](mailto:SupportEMEA_PG@woodward.com)